



GENERATOR TYPE ECP 34-3L/4 A

Document : DS276A/1

issue 000 date 11/11/2013

Electrical Characteristics										
Frequency	Hz	50				60				
Voltage (series star)	V	380	400	415	440	415	440	460	480	
Rated power class H	kVA	155	160	160	150	165	185	192	192	
	kW	124	128	128	120	132	148	154	154	
Rated power class F	kVA	140	145	145	135	150	160	173	173	
	kW	112	116	116	108	120	128	138	138	
Regulation with DSR		±1% with any power factor and speed variations between -5% +30%								
Insulation class		H								
Execution		Brushless								
Stator winding		12 ends								
Rotor		with damping cage								
Efficiencies class H	4/4	%	93,4	93,5	93,2	93	94,6	95,1	95,2	95,3
(see graph. for details)	3/4	%	93,4	93,7	93,6	93,3	95	95,2	95,3	95,5
	2/4	%	92,2	92,3	92,3	92,1	93,8	93,9	94	94,1
	1/4	%	89,8	89,6	89,4	89,4	91,2	91,2	91,2	91
Reactances (f. l.cl. F)	Xd	%	225,4	210	195,1	162,7	241,4	240,8	228,7	210
	Xd'	%	18,7	17,4	16,2	13,5	20,0	20,0	18,9	17,4
	Xd''	%	7,8	7,3	6,8	5,7	8,4	8,4	7,9	7,3
	Xq	%	153,5	143	132,8	110,8	164,4	164,0	155,7	143
	Xq'	%	153,5	143	132,8	110,8	164,4	164,0	155,7	143
	Xq''	%	33,4	31,1	28,9	24,1	35,8	35,7	33,9	31,1
	X ₂	%	20,7	19,3	17,9	15,0	22,2	22,1	21,0	19,3
	X ₀	%	3,2	2,97	2,8	2,3	3,4	3,4	3,2	3,0
Short Circuit Ratio	Kcc		0,44	0,48	0,51	0,61	0,41	0,42	0,44	0,48
Time Constants	Td'	sec.	0,04							
	Td''	sec.	0,0096							
	Tdo'	sec.	1,91							
	Tα	sec.	0,017							
Short Circuit Current Capacity		%	>300				>350			
Excitation at no load	Amp.		0,35	0,45	0,6	0,7	0,2	0,25	0,3	0,4
Excitation at full load	Amp.		2,3	2,5	2,6	2,7	2,2	2,3	2,4	2,5
Overload (long-term)		%	1 hour in a 6 hours period 110% rated load							
Overload per 20 sec.		%	300							
Stator Winding Resistance (20 °C)	Ω		0,015							
Rotor Winding Resistance (20 °C)	Ω		4,35							
Exciter Resistance (20 °C)	Ω		Rotor : 0,410				Stator : 15,28			
Heat dissipation at f.l.cl.H	W		8762	8898	9339	9032	7535	7626	7745	7575
Telephone Interference			THF < 2%				TIF < 40			
Radio interference			EN61000-6-3, EN61000-6-2. For others standards apply to factory							
Waveform Distors.(THD) at f. load	LL/LN %		1,7 / 1,8							
Waveform Distors.(THD) at no load	LL/LN %		2,4 / 2,5							
Mechanical characteristics										
Protection			IP 21 (other protection on request)							
DE bearing			6314.2RS							
NDE bearing			6311.2RS							
Weight of wound stator assembly	kg		168							
Weight of wound rotor assembly	kg		111							
Weight of complete generator	kg		485							
Maximun overspeed	rpm		2250							
Unbalanced magnetic pull at f.l.cl.F	kN/mm		5,4							
Cooling air requirement	m ³ /min		19,3				23			
Inertia Constant (H)	sec.		0,099				0,119			
Noise level at 1m/7m	dB(A)		79 / 65				83 / 69			

All technical data are to be considered as a reference and they can be modified without any notice

This document is a propriety of Mecc Alte S.p.a..All rights reserved.



GENERATOR TYPE ECP 34-3L/4 A

Document : DS276A/2

issue 000 date : 11/11/2013

50 Hz

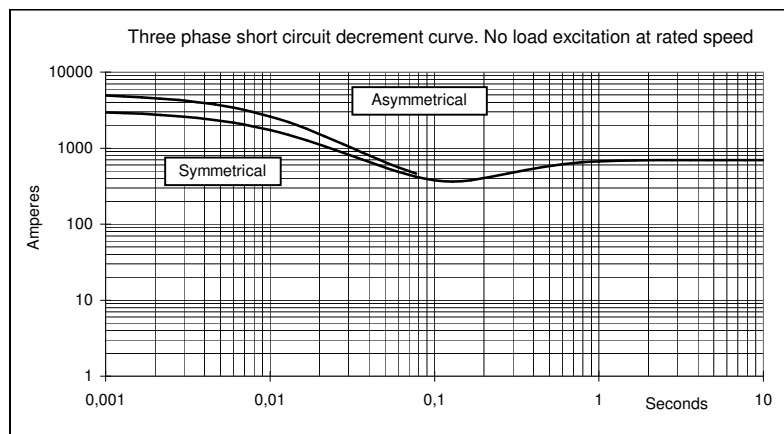
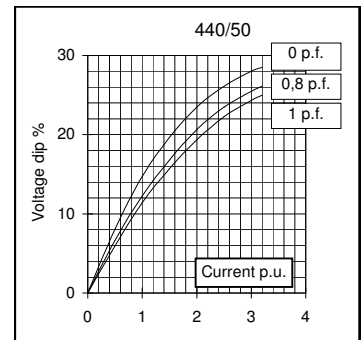
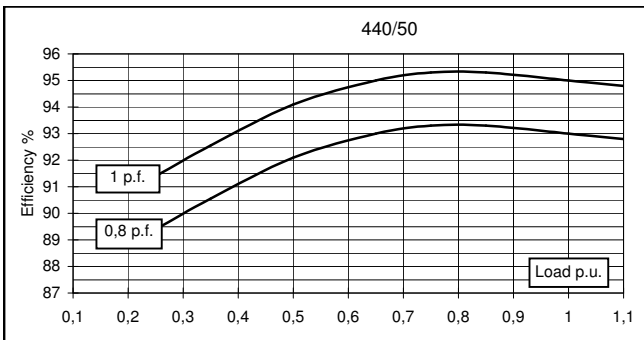
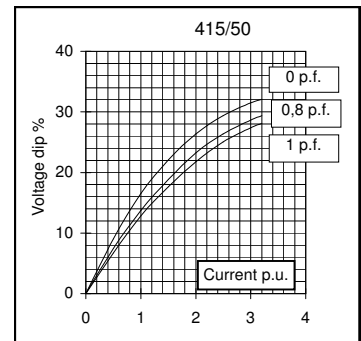
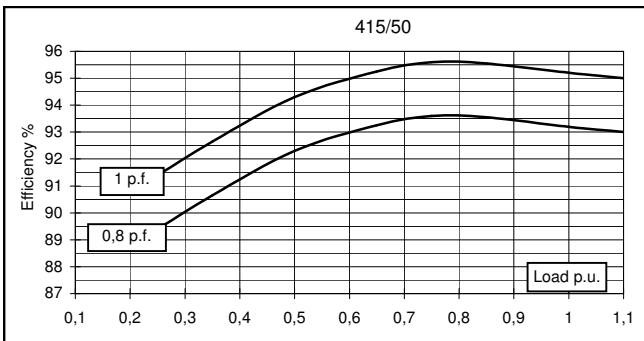
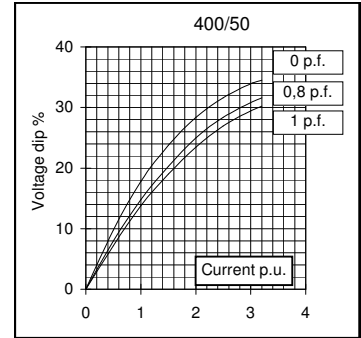
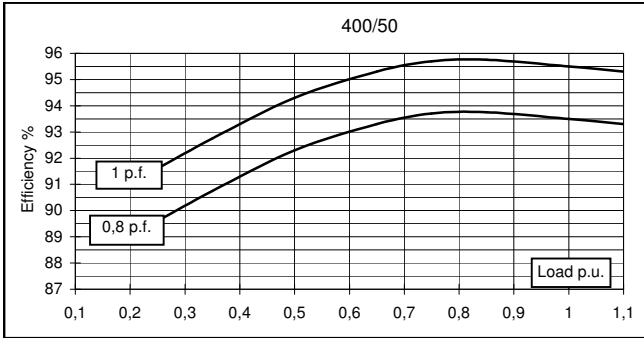
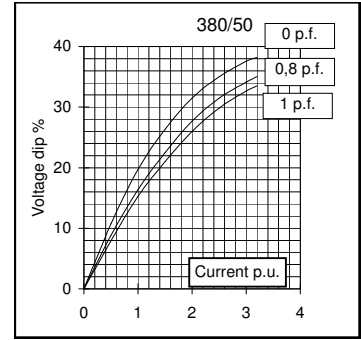
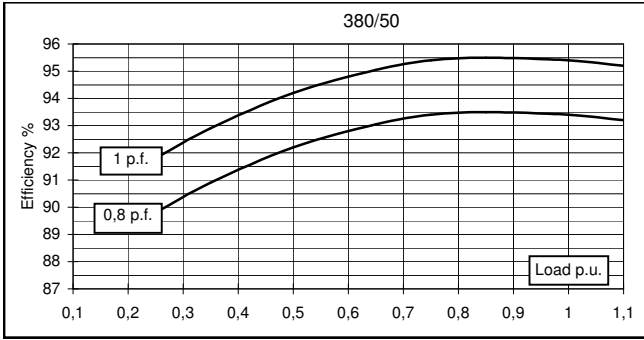

60 Hz

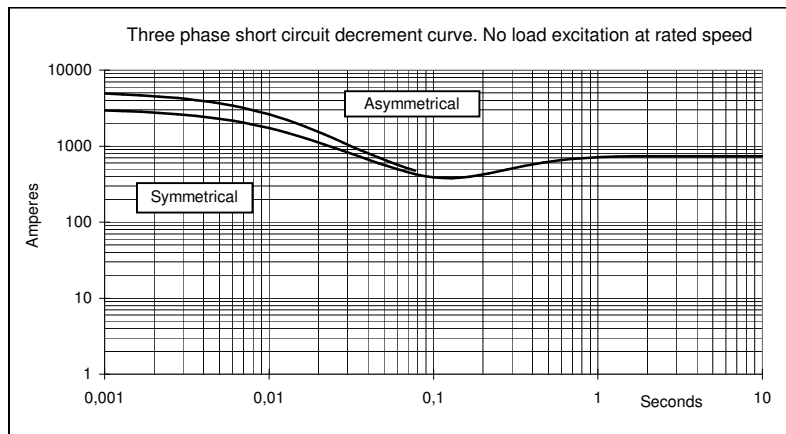
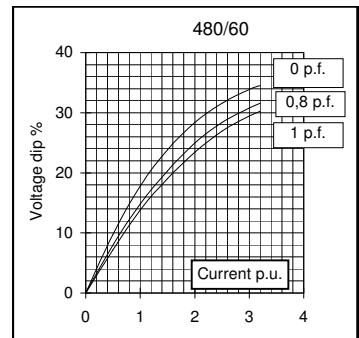
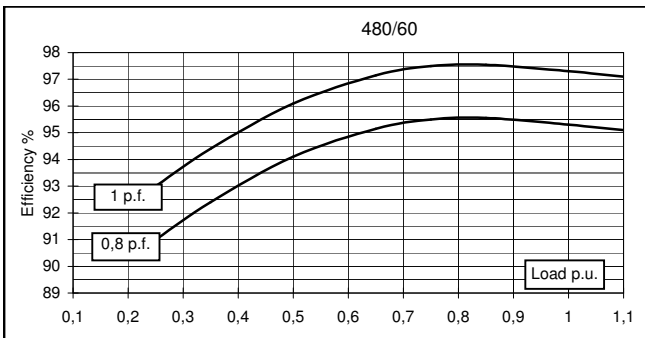
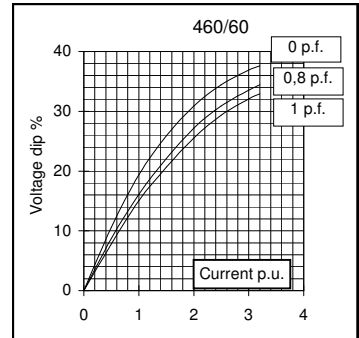
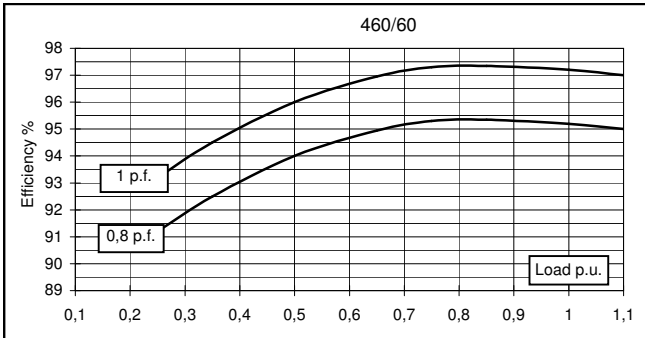
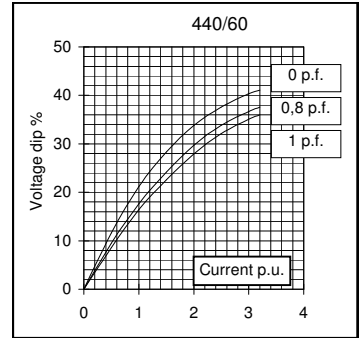
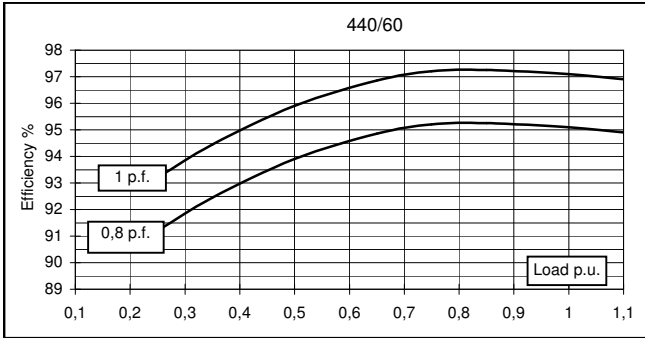
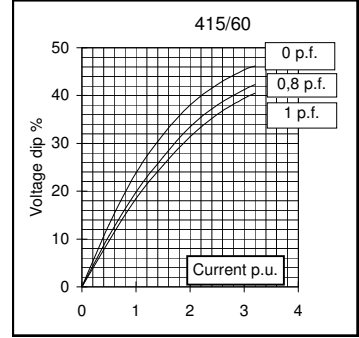
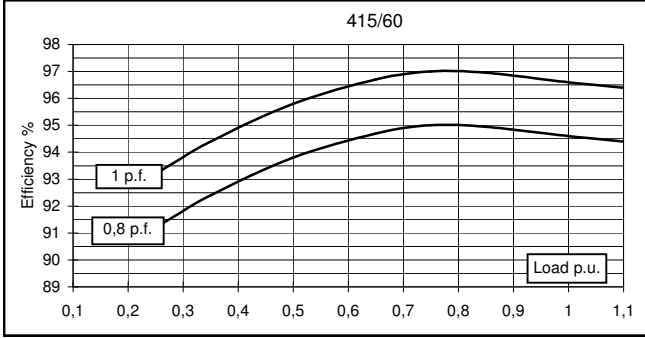

TWO BEARING MOMENTS OF INERTIA

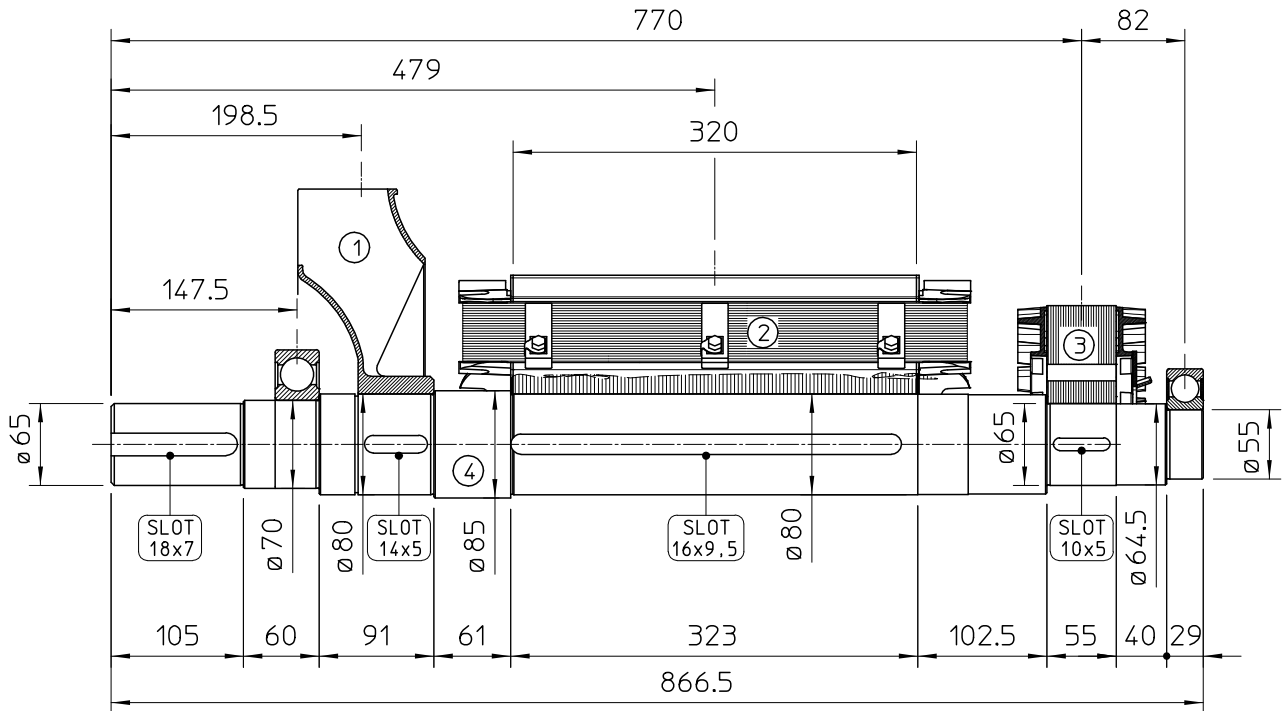

POS.	COMPONENT	WEIGHT (kg)	J (kgm ²)
1	FAN	3.6	0.0451
2	MAIN ROTOR	111.9	1.0123
3	EX. ROTOR	14.5	0.0874
4	SHAFT	29.6	0.0218
TOTAL		159.6	1.1666

TWO BEARING DIMENSIONS

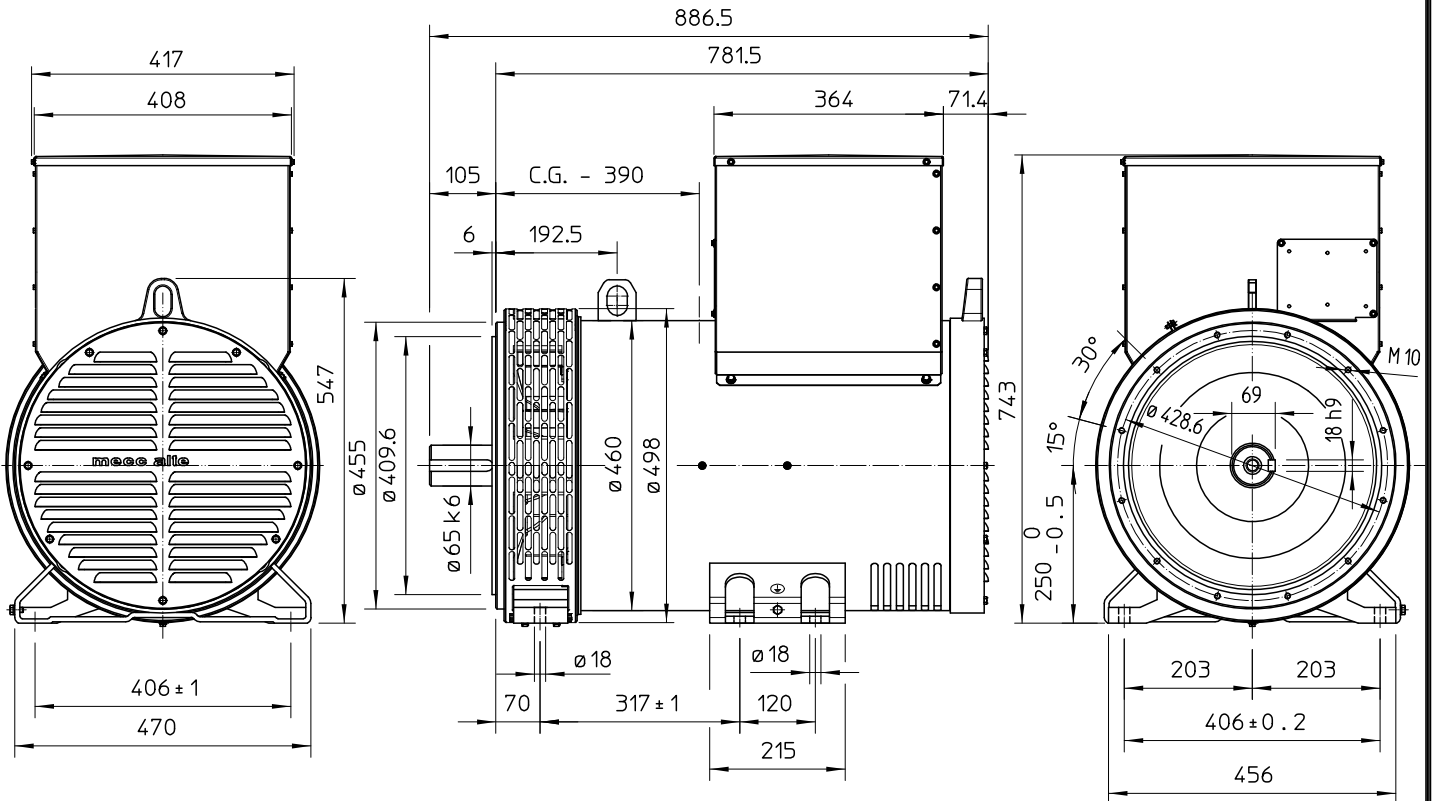

C.G.= GRAVITY CENTER

SINGLE BEARING MOMENTS OF INERTIA

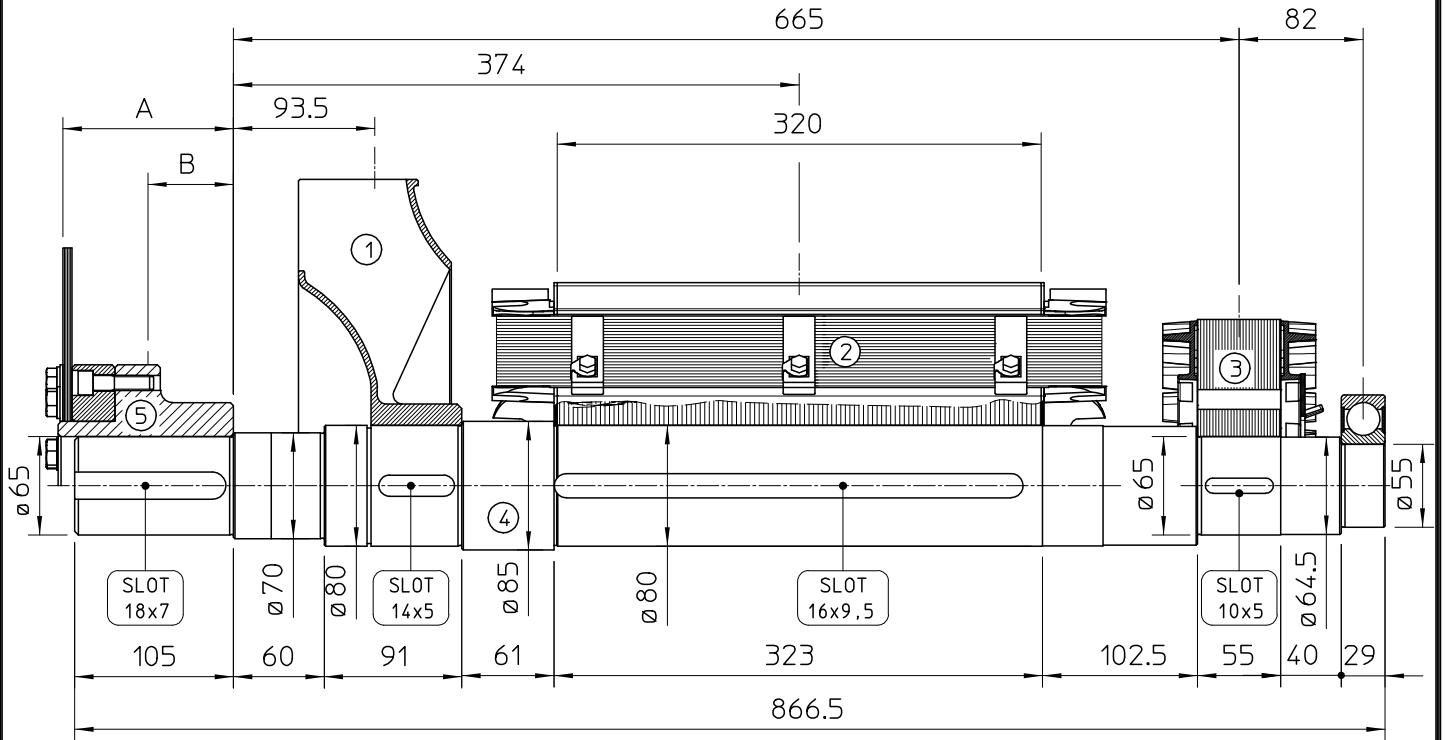

POS.	COMPONENT	WEIGHT (kg)	J (kgm ²)
1	FAN	3.6	0.0451
2	MAIN ROTOR	111.9	1.0123
3	EX. ROTOR	14.5	0.0874
4	SHAFT	29.6	0.0218
TOTAL		159.6	1.1666

SAE N°	5		SHAFTS COUPLING FLEX PLATE	
	A	B	WEIGHT kg	J kgm ²
10	112.8	35.6	13.5	0.0770
11 1/2	98.6	71.5	12.4	0.0956
14	84.4	68.6	14.8	0.2360

SINGLE BEARING DIMENSIONS

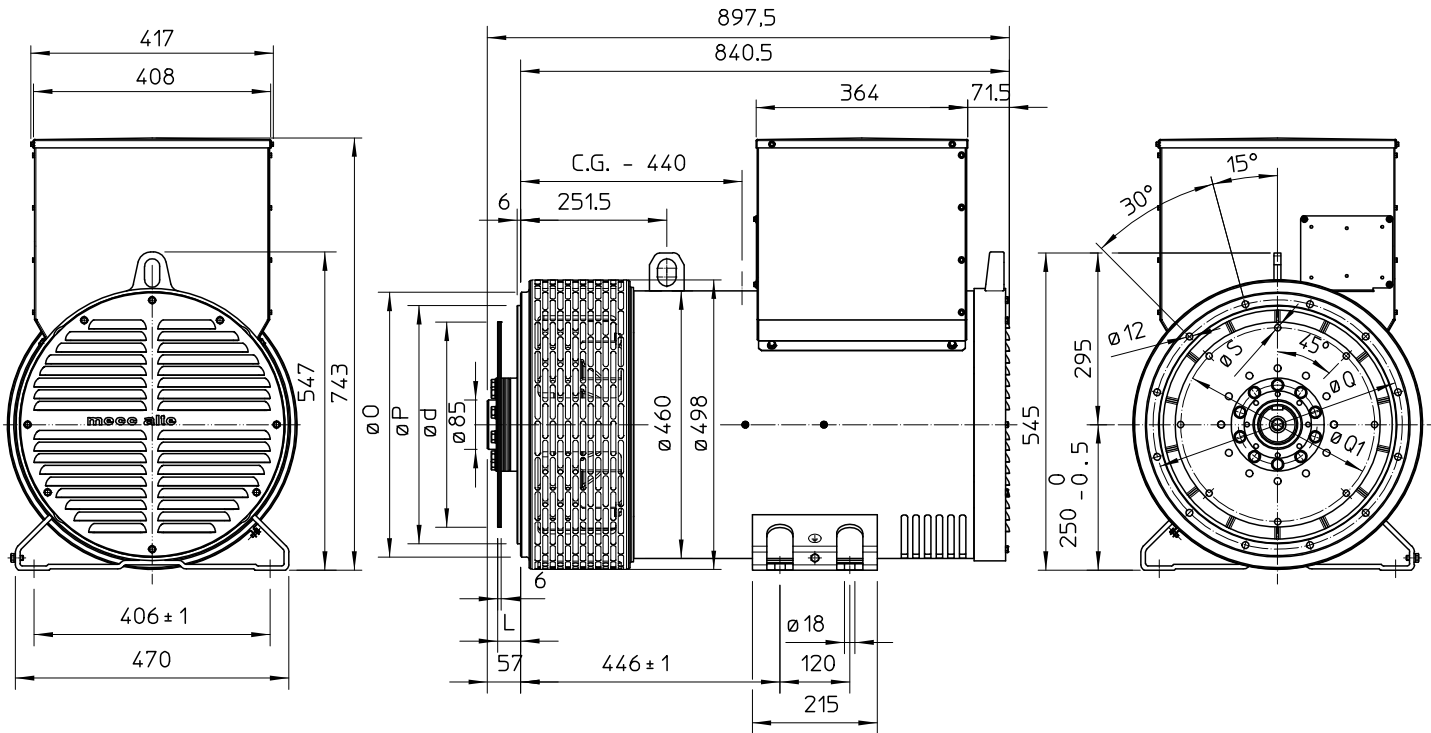

SAE N.	FLANGIA / FLANGE BRIDE / FLANSCH		
	O	P	Q
3	451	409.6	428.6
2	489	447.7	466.7
1	552	511.2	530.2

SAE N.	GIUNTI A DISCHI / DISC COUPLING DISCQUE DE MONOPALIER / SCHEIBENKUPPLUNG			
	L	d	Q1	S
10	53.8	314.32	295.27	11
11 1/2	39.6	352.42	333.37	11
14	25.4	466.72	438.15	14

C.G.= GRAVITY CENTER